

BREAKTHROUGH CORD CONNECTOR

The breakthrough cord connector applies only to Cellular shades. *Pleated and pleated-cellular shades do not include the Breakthrough Cord Connector.*



WARNING

To avoid entanglement and strangulation, keep cords out of the reach of young children. Move cribs and furniture away from blind cords.

To further reduce hazards, this shade was built with a cord connector which was designed to break apart when force is applied from the top.

No safety system is fail-safe. KEEP CORDS OUT OF REACH OF SMALL CHILDREN!

If your cord connector should happen to break apart, follow the instructions below to reassemble.

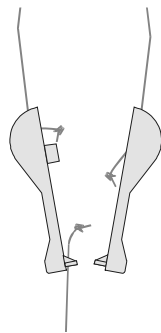
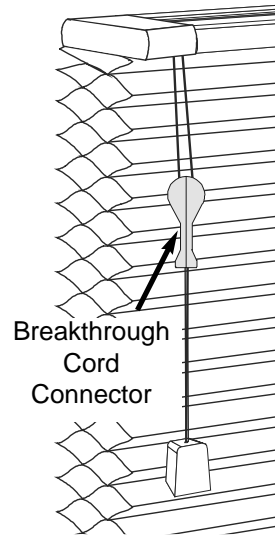

When the connector is open, each side has a cord coming in at the top, one side has a cord coming in from the bottom.

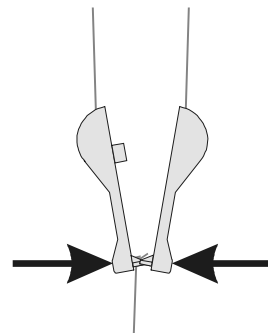

Fit the bottom edges together. The side with the cord fits into the side without the cord.

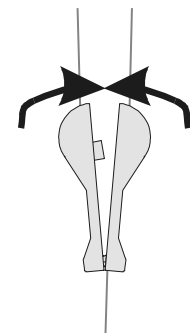

Swing the top ends together and press in the middle to fully connect.

PROTECT YOUR CHILDREN

Be aware that it is possible for children to strangle in window covering cords. To reduce the occurrence of accident, all cords must be kept out of the reach of children, including infants. Cord cleats are an effective way to implement this essential precaution.

Mount the cord cleat at a safe height, taking into account furniture or other objects upon which a child may climb. Then, after each use of the shade, simply wrap the excess cord around the cleat. It's fast, easy and safe.

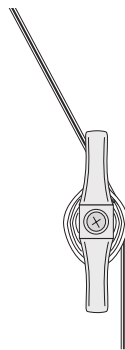

To protect your children, we are pleased to provide cord cleats free of charge upon request.

Equalization

Standard Rectangular shades use a system that allows easy leveling of the bottom rail. This applies only to Cellular, Pleated and Privacy Pleated shades. *Pleated-cellular shades do not include the equalization plugs in the bottom rail.*

If the shade length and equalization is satisfactory, simply trim the excess cord hanging below the bottom rail.

If adjustments are necessary, pull the excess cord at the bottom of the shade down until the Bottom Rail Plug is released (fig. A).

Push the cord up or down through the Bottom Rail Plug (figs. B & C).

If the cord needs to be longer, slide the bottom end of the cord up into the wedge and slide the wedge down to take up slack.

If the cord needs to be shorter, slide the top end of the cord down into the wedge and slide the wedge up to take up slack.

Adjust the position of the plug as necessary (fig. D).

Feed the cord back through the Bottom Rail Plug (figs. E & F).

Push the Bottom Rail Plug back into the Bottom Rail Pocket.

When bottom rail adjustments have been made, trim the excess cord hanging below the bottom rail.

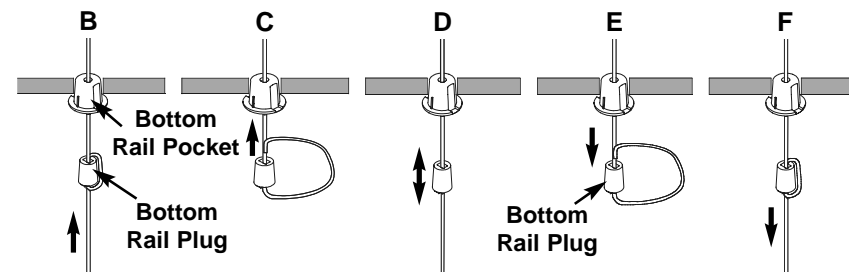
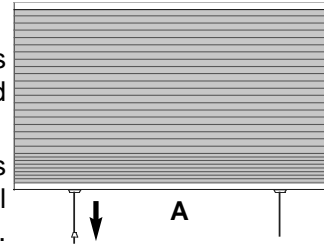

HOLD DOWN BRACKET (Optional)

Optional Hold Down Brackets are mounted with the supplied screws. With the shade at its proper drop, place the pin of each Hold Down into the hole in each End Cap and mark the screw holes. Make sure the pins are level and aligned. Raise the shade, then screw the Hold Down Bracket into the mounting surface.

Cellular and Pleated Shades

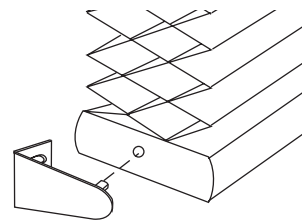

Pleated Cellular Shades

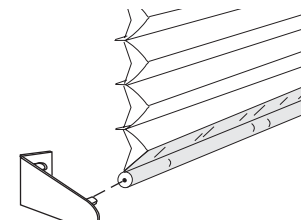

CLEANING AND CARE

The Shade fabric is easy to care for. Regular dusting with a feather duster or vacuum cleaner brush is recommended. Most stains can be blotted with a damp sponge and mild detergent. For problem stains, the shade can be removed from the Installation brackets and soaked in warm water. When damp, raise shade tightly to re-crisp pleats. Before using anything stronger than mild detergent and lukewarm water, test an unobtrusive corner of the shade. If you have any questions, call your dealer for advice.

152001

UNV1030F

Installation Instructions for

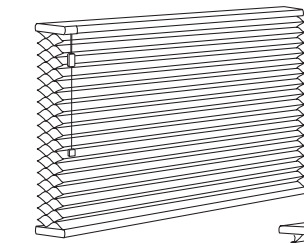

Honeycomb Cellular Shades

Pleated Cellular Shades

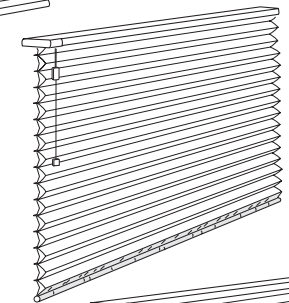

Pleated Shades

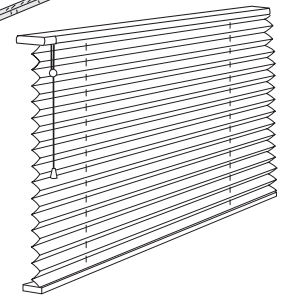

Privacy Pleated Shades

Pleated shades with no visible holes

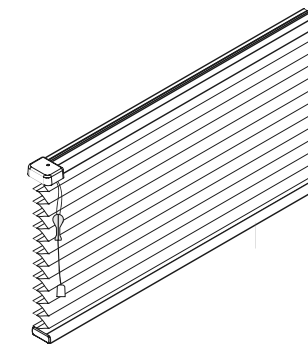

Our window fashions represent a design breakthrough in style, efficiency and function. Our Cellular shades feature 100% non-woven polyester fabric providing a soft diffused light and high level of privacy. The unique hardware system is designed to provide years of reliable service when properly installed.

Please take a few minutes to read through these instructions before beginning.

BASICS

A few simple tools are required:

- Measuring tape
- Power drill, drill bits
- Hex head and/or Phillips driver bit
- Pencil

Additional fasteners other than those sent with your shade may be required depending on the mounting surface. Wallboard and plaster require the use of anchors such as expansion or toggle bolts. Brick, tile or stone need special plugs and drill bits. Remember to always pre-drill holes in wood to avoid splitting.

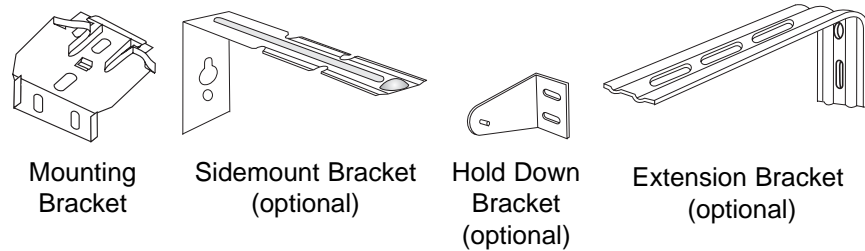

BRACKET INSTALLATION

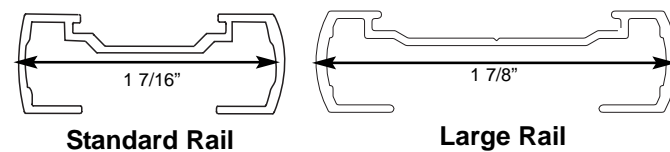

Use this Number of Brackets:

For shade widths of:	Standard Rail		Large Rail	
	Inside or Outside Mount	Inside Mount	Outside Mount	
Up to 40"	2	2	2	
>40" to 72"	3	3	4**	
>72" to 84"	4	4	5**	
>84" to 120"	5*	5	6**	
>120 and up		6	7**	

End brackets should be located with centerlines 2 1/2" in from each end.

*On standard rail shades over 84" wide it is recommended to use a second bracket located next to the end bracket at the Cord Lock.

**On large rail shades over 40" wide it is recommended to use a second bracket located next to the end bracket at the Cord Lock.

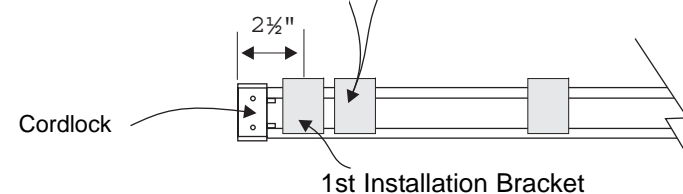

Depending on the width of the shade, additional brackets may be necessary evenly spaced between the two end brackets.

Using the Installation Bracket as a template, measure and mark the center lines. When mounting brackets, make sure they are in line and level.

INSIDE MOUNT

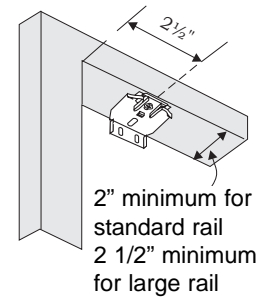

The brackets are mounted flat against the top sill surface.

To fully recess the shade requires a flat surface with a minimum depth of 2" for standard rail or 2 1/2" for large rail.

Shallow mounting requires 3/4" minimum.

OUTSIDE MOUNT

The brackets are mounted with two screws through the back end of the bracket flat against the window molding or the wall above the window. The bracket requires a minimum surface 3/4" high.

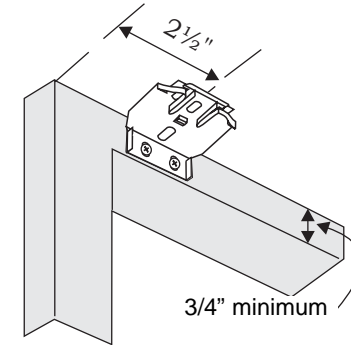

SIDEMOUNT BRACKETS (Optional)

Line the bracket top with the desired height of the top of the headrail.

Mark holes for screws. Remove brackets and drill holes.

Insert screws for keyhole slots only. Approximately 1/8" of the screw should be left protruding.

Pull the cord lock assembly partially out of the headrail and slide the bracket on as shown. Push the cord lock assembly and bracket back all the way into the rail.

Remove the endcap from the opposite end of the headrail. Slide the remaining side mount bracket on the headrail. Replace the endcap before sliding the bracket all the way into the headrail.

Hook one bracket onto the screw in the window frame, using the keyhole slot. Bring the other end bracket over the screw at the other side of the frame. Slide down, flexing bracket inward until the screw engages in the keyhole slot.

Make sure both brackets are slipped down all the way in the keyhole slot so that the screw is in the top portion of the keyhole slot. Install a screw in the bottom hole of each bracket. Tighten all screws.

EXTENSION BRACKETS (Optional)

Optional Extension Brackets are used to project the back of the shade up to 2 3/8" from the mounting surface. Attach the Installation Bracket to the Extension Bracket with the nut and bolt provided.

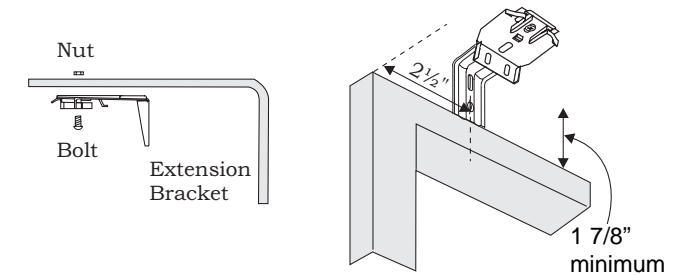

TWO-ON-ONE HEADRAIL SPLICER (Standard headrail only)

For Standard rail shades ordered as a Two-on-One Headrail using the Splicer piece, insert the Splicer into the Headrail of both shades as shown. Lock into place using 3/8" Tek Screws provided.

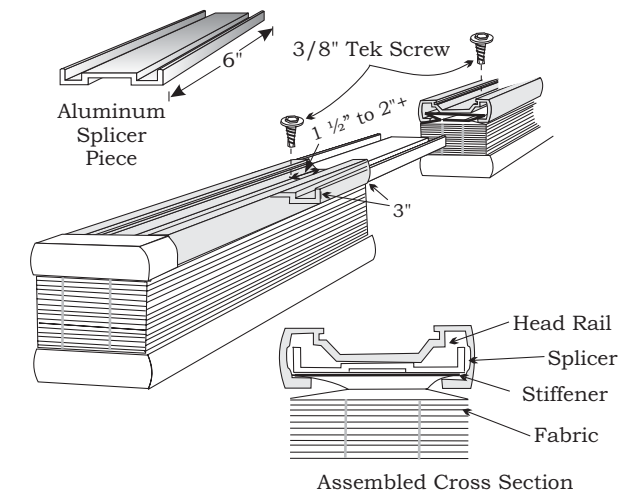

HANGING THE SHADE

Unwind the cord from the shade.

1. Hold the shade up near the brackets and insert the front clip of the bracket into the front groove of the rail.
2. Make sure the shade is centered in the window opening.
3. Push the rail back and up until the back clips of the bracket are inserted in the back groove of the rail.

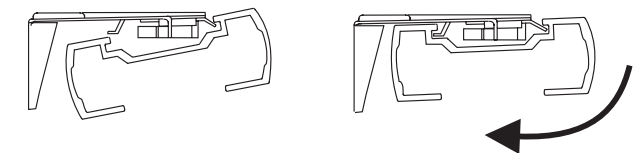

To remove shade, reverse procedure.

CORDLOCK OPERATION

To lower or release shade, pull the cord inward toward the center of the shade.

To raise or lock the shade, pull the cord straight down and outward toward the edge of the shade.

