

CORNICES, VALANCES AND PALLADIAN WINDOW SHELF

TABLE OF CONTENTS

FEATURES AND SIZE CONSIDERATIONS

Summary2
Wood Characteristics2
Cornice and Valance Size Considerations3
Palladian Window Shelf Size Considerations3

OPTIONS

Wood Cornices4
Wood Valances5
Composite and Faux Wood Valances6
Decorative Keystones7
Splice Requirements7
Palladian Window Shelf8

GENERAL INFORMATION

Valance Returns: Horizontal Blinds	9-10
Wood Cornice and Valance Return Information11
Composite and Faux Wood Valance Return Information12
How to Measure for Valance Returns12
How To Measure and Order Cornices and Valances13
How To Measure a Special Splice Location14
Custom Color14
Mounting Brackets15

Features

Cornices and Valances easily lend an impressive touch to windows and doors. Used on their own or over window treatments, Cornices and Valances are as decorative as they are functional.

Palladian Window Shelves create a mounting surface for unique or difficult installations.

- Unique styles of Wood Cornices, Wood Valances and Faux Wood Valances provide the perfect solution for any décor
- Wood Cornices and Valances are crafted from premium North American hardwood and are available in all paints and stains to coordinate with Graber® Wood blinds, as well as unfinished or with custom color
- Dress up a drab window
- Enlarge a window
- Keystones are included with a spliced Cornice or Wood Valance
- Additional keystones are available as a surcharge option for Cornices or Wood Valances that do not require splices

WOOD CHARACTERISTICS



Flat Grain



Grain Change



Tiger Striping



Burl/Bird's Eye



Pin Knots



Mineral Marks

Wood used to manufacture Graber wood valances and cornices has many natural characteristics which make it truly unique. The following are all natural characteristics of wood, and we do not consider them to be defects:

Grain	The direction, size and appearance of wood fibers vary greatly depending on where the wood is cut from within the tree.
Burl	Formed from an irregular growth on the outer edge of the tree.
Bird's Eye	Small area on the surface of the board where fibers are contorted to form circular figures that resemble birds' eyes.
Pin Knots	Vary in size, shape, structure and color.
Mineral Marks	Dark or discolored areas caused by minerals which the tree extracts from the water or soil. Can be either a streak or a stain, usually blackish blue.

Please be assured that these markings in no way affect the durability or the structural integrity of the product.

Natural variations in color and grain are inherent in the beauty of wood. These variations are within established industry guidelines and should be expected. When two or more pieces of wood are spliced together to create wider valances or cornices, there may be variations in the dye lot and grain between the sections. In addition, valances and cornices may stain slightly darker or lighter than the samples shown in the sample books and selectors.

Size Considerations

SIZE CONSIDERATIONS: CORNICE AND VALANCE

Type of Valance or Cornice	Minimum Width		Maximum Width Without Splicing		Maximum Width With Splicing	
	Inside Mount	Outside Mount	Inside Mount NO Returns	Outside Mount or Inside Mount with Returns	Inside Mount	Outside Mount
3" (7.7 cm) Classic Wood Valance	8 1/4" (21.0 cm)	8" (20.4 cm)	100 1/4" (254.7 cm)	98 3/8" (249.9 cm)	300" (762 cm)	298 7/8" (759.2 cm)
3 1/8" (8.0 cm) Beaded Wood Valance						
3 1/2" (8.9 cm) Legacy Wood Valance						
4 1/2" (11.5 cm) Symphony Wood Valance						
2 1/2" (6.4 cm) Classic Composite or Faux Wood Valance ⁺						
3" (7.7 cm) Majestic Composite or Faux Wood Valance ⁺			106 5/8" (270.9 cm)	105 3/8" (267.7 cm)	300" (762.0 cm)	298 3/4" (758.9 cm)
4 1/2" (11.5 cm) Symphony Wood Cornice*	8 1/4" (21.0 cm)	8" (20.4 cm)	94" (238.8 cm)	92 1/2" (235.0 cm)	94" (238.8 cm)	92 1/2" (235.0 cm)
5 1/2" (14.0 cm) Noble Wood Cornice ^				92 1/8" (234.0 cm)		
7 1/2" (19.1 cm) Noble Wood Cornice ^				91 3/8" (232.1 cm)	366" (929.7 cm)	366" (929.7 cm)
5 1/2" (14.0 cm) Regal Wood Cornice ^				91 1/8" (231.5 cm)		
7 1/2" (19.1 cm) Regal Wood Cornice ^				90" (228.6 cm)		

Note: Cornices and Valances wider than the widths shown in the chart above will be manufactured in multiple sections. The sections must be assembled during installation.

Customer may request specific locations for the splices as long as it does not exceed our maximum single piece size.

All requests for additional Cornice or Wood Valance splices require a keystone.

The keystone surcharge applies to each additional splice.

*4 1/2" (11.5 cm) Symphony Cornices cannot be spliced and keystones are not available.

^Inside mount Wood Cornices that require a keystone cannot be mounted flush to the top of the window casing. There will be approximately a 1/4" (0.7 cm) gap at the top and the installation brackets may be visible with this application.

+Keystones are not available with Composite and Faux Wood Valances.

These formulas are used to calculate **BACKSIDE** Valance measurements.

Inside Mount with NO Returns	Ordered Width - 1/16" (0.2 cm)
Inside Mount with Returns	Ordered Width + 3/4" (2.0 cm)
Outside Mount with NO Returns	Ordered Width + 1/2" (1.3 cm)
Outside Mount with Returns	Ordered Width + 3/4" (2.0 cm)

These formulas are used to calculate **BACKSIDE** Cornice measurements.

All except Soft Vertical and Sliding Panels	
Inside Mount with NO Returns	Ordered Width - 1/16" (0.2 cm)
Outside Mount with Returns	Ordered Width + 3/4" (2.0 cm)
Soft Vertical and Sliding Panels	
Inside Mount with NO Returns	Ordered Width - 1/16" (0.2 cm)
Outside Mount with Returns	Ordered Width + 1/2" (1.3 cm)

If the product option of OTHER is selected during entry, the BACKSIDE cornice/valance measurement will be the exact width entered. There will be no additions or deductions taken. Cornice or valance return size must be specified.

SIZE CONSIDERATIONS: PALLADIAN WINDOW SHELF

	Minimum Width Inside Mount only	Maximum Width Inside Mount only	Minimum Depth	Maximum Depth
Palladian Window Shelf	7" (17.8 cm)	96" (243.9 cm)	2" (5.1 cm)	4" (10.2 cm)

Note: Inside mount application only. The finished shelf will be ordered width less 1/16" (0.2 cm).

The shelf is designed for end mounting, no center supports are available.

End mounting brackets must be mounted to a flat vertical surface.

If installation is inside an arch, the top of the palladian shelf must be mounted at or below the start of the arch curve.

Depending on the width of the window opening and the weight of the blind or shade, deflection up to 1/2" (1.3 cm) may occur.

Options

WOOD CORNICES

- Crafted from premium North American hardwood
- Fine furniture-quality finish
- L-brackets are included for easy installation
- Noble and Regal cornices available in all paints and stains to coordinate with Traditions® Wood blinds, as well as unfinished or with custom color

- One side return available; opposite end will be straight cut
- Outside mount has mitered corners, returns and a dust cover to conceal the top of the blind
- Inside mount has straight cut ends, no returns, no dust cover
- **Cornices not available on Bay or Corner windows**

NOTE: Wood cornice will be shipped separate from blinds. Manufacturer recommends installing blind and cornice at the same time.

Regal Wood – Outside Mount

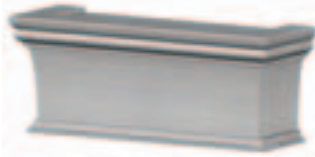

Regal Wood – Inside Mount

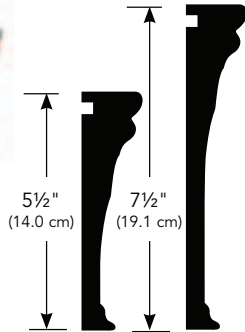
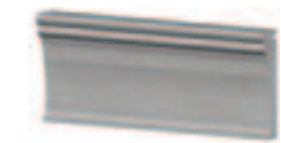

Regal Wood Cornice

The magnificent Regal Wood Cornice, available in either a 5½" (14.0 cm) or 7½" (19.1 cm) size and in stained or painted finishes, crowns your blind with style and sophistication.

Noble Wood Cornice

The stately design of the Noble Wood Cornice, available in either a 5½" (14.0 cm) or 7½" (19.1 cm) size and in stained or painted finishes, lends an impressive appearance to larger, wider windows.

Noble Wood – Outside Mount



Noble Wood – Inside Mount

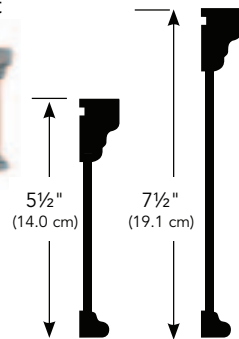

PAINT COLORS

Almond	1724
Angora	1052
Antique White	1026
Base Black	1767
Base White	1051
Crisp White	1712
Custom Color	CUSP
Dover White	1683
Ivory	1325
Manatee	1765
Overcast	1764
Snowflake	1603
Stucco	1963

STAIN COLORS

Cappuccino	1546	Horseshoe	1760
Cherry Wood	1014	Light Pecan	1020
Cognac	1465	Natural	1007
Custom Color	CUSS	Peru	1688
Dark Cherry	1316	Pickled White	1762
Dark Walnut	1641	Saddle Brown	1694
Espresso	1716	Sienna	1685
Golden Oak	1030	Truffle	1054
Harbor Grey	1761	Unfinished	1717
Henna	1949	Walnut	1012
Homestead Oak	1943	Wheat	1710
Honey Maple	1013		

For the Custom Color Pricing surcharge, see the Pricing Charts.

Symphony Wood Cornice

Available in stained or painted finishes to coordinate with most Graber wood blind colors.

Symphony Wood – Outside Mount



Symphony Wood – Inside Mount

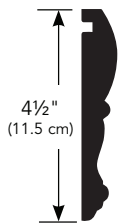

PAINT COLORS

Almond	1724
Angora	1052
Antique White	1026
Base Black	1767
Base White	1051
Crisp White	1712
Custom Color	CUSP
Dover White	1683
Ivory	1325
Manatee	1765
Overcast	1764
Sandblast Base White*. SB051	
Sandblast Snowflake*. SB603	
Snowflake	1603
Stucco	1963

STAIN COLORS

Cappuccino	1546	Horseshoe	1760
Cherry Wood	1014	Light Pecan	1020
Cognac	1465	Natural	1007
Custom Color	CUSS	Peru	1688
Dark Cherry	1316	Pickled White	1762
Dark Walnut	1641	Saddle Brown	1694
Espresso	1716	Sienna	1685
Golden Oak	1030	Truffle	1054
Harbor Grey	1761	Unfinished	1717
Henna	1949	Walnut	1012
Homestead Oak	1943	Wheat	1710
Honey Maple	1013		

For the Custom Color Pricing surcharge, see the Pricing Charts.

*Keystones are not available in sandblast finish. When sandblast is chosen for wood cornice any required or additional keystones will come in matching paint color without sandblast texture.

Options

WOOD VALANCES

- Painted and stained valances crafted from premium North American hardwood
- Fine furniture-quality finish
- Inside mount has straight cut ends, no returns
- Outside mount has mitered corners and returns

- Custom returns may be ordered, for both inside and outside mount up to 8" (20.4 cm), minimum returns is ½" (1.3 cm)
- **Not available on Bay or Corner windows when product selected or an option within the product is not available with bay or corner application**

NOTE: Wood valance will be shipped separate from blinds. Manufacturer recommends installing blind and valance at the same time.

3" (7.7 cm) Classic Valance

Available in all colors listed below.

Available in Bamboo and Barnwood Wood – 2½" (6.4 cm) profile, not available with keystones

BAMBOO COLORS

Light Oak B010
Natural B007

BARNWOOD COLORS

Sunbleached 1073
Windswept 1072

Classic – Outside Mount



Classic – Inside Mount

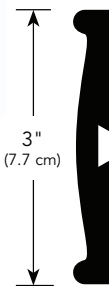

4½" (11.5 cm) Symphony Wood Valance

Available in all colors listed below.

Symphony Wood – Outside Mount



Symphony Wood – Inside Mount

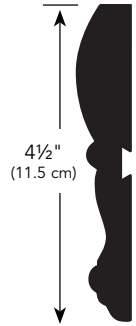

3½" (8.9 cm) Legacy Valance

Available in all colors listed below.

Available in Distressed Wood and Authentic Hardwood not available with keystones

DISTRESSED COLORS

Armoire 1076
Chipotle 1077
Twig 1070

AUTHENTIC HARDWOOD COLORS

Cherry C007
Maple M007
Walnut W007

Legacy: Outside Mount



Legacy: Inside Mount

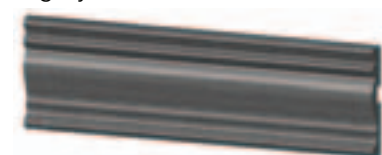

3⅞" (8.0 cm) Beaded Slat Valance

Available in all colors listed below.

Not available with Sandblast texture.

Beaded: Outside Mount



Beaded: Inside Mount

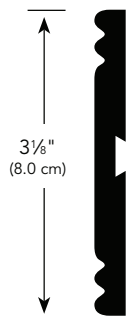

PAINT COLORS

Almond 1724	Ivory 1325
Angora 1052	Manatee 1765
Antique White 1026	Overcast 1764
Base Black 1767	Sandblast Base White* . . . SB051
Base White 1051	Sandblast Snowflake* . . . SB603
Crisp White 1712	Snowflake 1603
Custom Color CUSP	Stucco 1963
Dover White 1683	

STAIN COLORS

Cappuccino 1546	Horseshoe 1760
Cherry Wood 1014	Light Pecan 1020
Cognac 1465	Natural 1007
Custom Color CUSS	Peru 1688
Dark Cherry 1316	Pickled White 1762
Dark Walnut 1641	Saddle Brown 1694
Espresso 1716	Sienna 1685
Golden Oak 1030	Truffle 1054
Harbor Grey 1761	Unfinished 1717
Henna 1949	Walnut 1012
Homestead Oak 1943	Wheat 1710
Honey Maple 1013	

*For the Custom Color Pricing surcharge, see the Pricing Charts.

*Keystones are not available in sandblast finish. When sandblast is chosen for wood valance any required or additional keystones will come in matching paint color without sandblast texture.

Options

COMPOSITE AND FAUX WOOD VALANCES

- Composite and Faux Wood Valance options are ideal for a finishing look in a high humidity room
- Includes mounting hardware for specified product use
- Inside Mount has straight cut ends, no returns
- Outside Mount has mitered corners and returns
- Custom returns may be ordered, for both inside and outside mount up to 8" (20.4 cm), minimum returns is ½" (1.3 cm)
- **Not available on Bay or Corner windows when product selected or an option within the product is not available with bay or corner application**

NOTE: Composite and faux wood valances will be shipped separate from blind. Manufacturer recommends installing blind and valance at the same time.

Classic – Outside Mount



Classic – Inside Mount

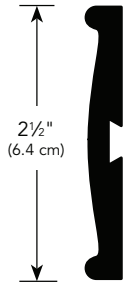

2½" (6.4 cm) Classic Composite and Faux Wood Valance
Adds a classic touch to any room.

Majestic – Outside Mount

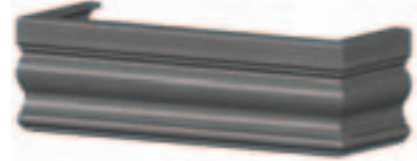

Majestic – Inside Mount

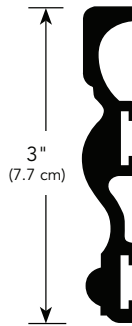
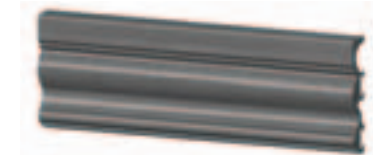

3" (7.7 cm) Majestic Composite and Faux Wood Valance
Add a decorative element to the window.

COMPOSITE WOOD COLORS

Antique White2026
Arctic White2539
Dark Cherry9316
Designer White2055
Golden Oak9030
Honey Maple9013
Snowflake2603
Streaked Cream2715
Streaked Prairie2787
Streaked Sandstone2686
Swiss Coffee2692

PREMIUM FAUX WOOD COLORS

Cognac2465
Dark Cherry2316
Golden Oak2030
Honey Maple2013
Morel2706
Natural2007
Phantom2707
Saddle Brown2694
Sienna2685
Walnut2012
Wheat2710

FAUX WOOD COLORS

Almond5724
Buttermilk5078
Cherry5655
Coconut5630
Marshmallow5742
Milky Way5058
Natural5007
Nutmeg5264
Textured Buttermilk*5953
Textured Coconut*5299
Textured Milky Way*5304
Textured White*5951
White5035

*Classic valance will be textured.
Majestic valance will be color coordinated in a smooth finish.

Options

DECORATIVE KEYSTONES



- Decorative Keystones are required on Wood Cornices and Valances that require splicing
- The keystones will be equally spaced unless special splice locations are requested at time of order
- Keystones can be requested on Wood Cornices or Valances without a splice
 - Minimum width with a keystone: 12" (30.5 cm)
 - Maximum number of keystones: 3
- Keystones will be stained or painted to match the Valance or Cornice ordered as standard; optional different color selection available
- Keystones not available on Authentic Hardwood, Bamboo Wood, Barnwood Wood, Distressed Wood, Composite or Faux Wood Valances
- Keystones not available in sandblast

SPLICE REQUIREMENTS

Profile	Number of Sections	Number of Keystones	No Returns		With Returns (Inside Dimensions)	
			Minimum	Maximum	Minimum	Maximum
3" (7.7 cm) Classic Wood Valance	1	0	8" (20.4 cm)	100¼" (254.7 cm)	8" (20.4 cm)	98⅞" (249.9 cm)
3⅝" (8.0 cm) Beaded Wood Valance	2	1	100⅞" (254.8 cm)	200½" (509.3 cm)	98⅞" (250.1 cm)	198⅞" (504.6 cm)
3½" (8.9 cm) Legacy Wood Valance	3	2	200⅞" (509.5 cm)	300" (762.0 cm)	198⅞" (504.7 cm)	298⅞" (759.2 cm)
4½" (11.5 cm) Symphony Wood Valance	3	2	200⅞" (509.5 cm)	300" (762.0 cm)	198⅞" (504.7 cm)	298⅞" (759.2 cm)
5½" (14.0 cm) Noble Cornice	1	0	8" (20.4 cm)	94" (238.8 cm)	8" (20.4 cm)	92⅞" (234.0 cm)
	2	1	94⅞" (239.0 cm)	187⅞" (476.1 cm)	92⅞" (234.2 cm)	185⅞" (470.4 cm)
	3	2	187⅞" (475.3 cm)	280⅞" (711.6 cm)	185⅞" (470.6 cm)	278⅞" (706.8 cm)
	4	3	280⅞" (711.7 cm)	366" (929.7 cm)	278⅞" (707.0 cm)	366" (929.7 cm)
7½" (19.1 cm) Noble Cornice	1	0	8" (20.4 cm)	94" (238.8 cm)	8" (20.4 cm)	91⅞" (232.1 cm)
	2	1	94⅞" (239.0 cm)	186⅞" (474.2 cm)	91⅞" (232.3 cm)	184⅞" (467.6 cm)
	3	2	186⅞" (474.4 cm)	279⅞" (709.7 cm)	184⅞" (467.7 cm)	276⅞" (703.0 cm)
	4	3	279⅞" (709.8 cm)	366" (929.7 cm)	276⅞" (703.2 cm)	366" (929.7 cm)
5½" (14.0 cm) Regal Cornice	1	0	8" (20.4 cm)	94" (238.8 cm)	8" (20.4 cm)	91⅞" (231.5 cm)
	2	1	94⅞" (239.0 cm)	186⅞" (473.9 cm)	91⅞" (231.7 cm)	183⅞" (466.6 cm)
	3	2	186⅞" (474.1 cm)	279⅞" (709.0 cm)	183⅞" (466.8 cm)	276⅞" (701.7 cm)
	4	3	279⅞" (709.2 cm)	366" (929.7 cm)	276⅞" (701.9 cm)	366" (929.7 cm)
7½" (19.1 cm) Regal Cornice	1	0	8" (20.4 cm)	94" (238.8 cm)	8" (20.4 cm)	90" (228.6 cm)
	2	1	94⅞" (239.0 cm)	186" (472.5 cm)	90⅞" (228.8 cm)	182" (462.3 cm)
	3	2	186⅞" (472.6 cm)	278" (706.2 cm)	182⅞" (462.5 cm)	274" (696.0 cm)
	4	3	278⅞" (706.3 cm)	366" (929.7 cm)	274⅞" (696.2 cm)	366" (929.7 cm)

Outside Mount

- Wood Cornices and Valances requiring a splice will include a keystone (see chart above for details)
- Keystones are not available on Composite or Faux Wood Valances
- Keystones will be equally spaced unless special splice locations are requested
- Optional keystones can be ordered with single piece cornices or valances or in addition to required keystones
- Minimum width with a keystone is 12" (30.5 cm)
- Maximum number of keystones is 3

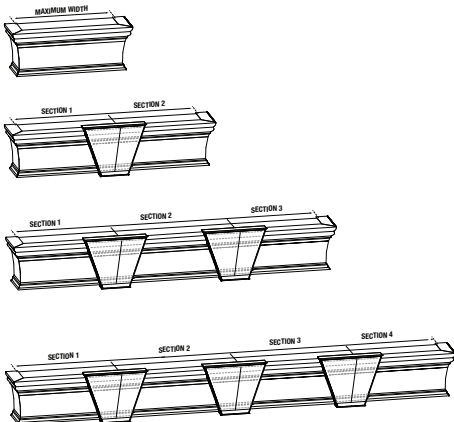

Inside Mount

- Wood Valances 100¼" (254.7 cm) or wider and Cornices 94" (238.8 cm) exact or wider will require a keystone
- Keystones are not available on Composite or Faux Wood Valances
- Keystones will be equally spaced unless special splice locations are requested
- Optional keystones can be ordered with single piece cornices or valances or in addition to required keystones
- Minimum width with a keystone 12" (30.5 cm)
- Maximum number of keystones is 3

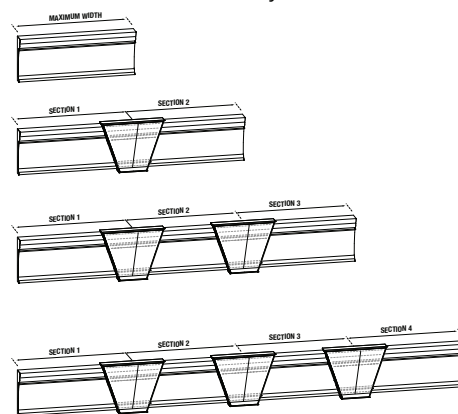

*NOTE: Inside mount cornices with a keystone do not mount flush at the top, there will be a slight gap.

Options

PALLADIAN WINDOW SHELF

A wood shelf or header that may be installed in applications lacking window frame for mounting a blind. Blinds or other window treatments may be installed either above or below the shelf.

Features

- Created from premium North American hardwood
- Use with any Graber® blind or shade
- Ideal for arch top windows
- Use as a divider for long windows
- Easy mount brackets included
- Available in all paints and stains to coordinate with Graber wood blinds, as well as unfinished or with custom color

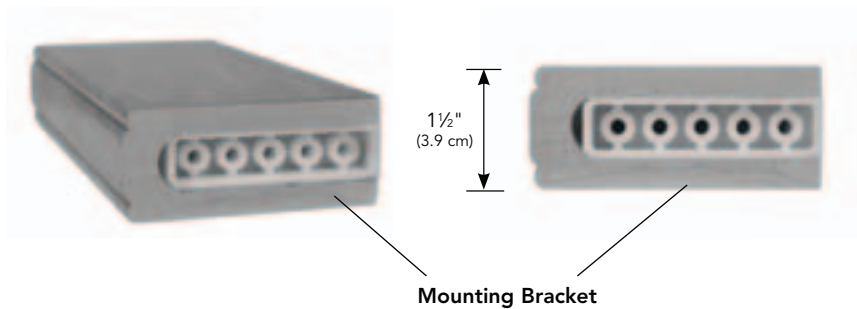

PAINT COLORS



Almond	1724	Dover White	1683
Angora	1052	Ivory	1325
Antique White	1026	Manatee	1765
Base Black	1767	Overcast	1764
Base White	1051	Snowflake	1603
Crisp White	1712	Stucco	1963
Custom Color	CUSP		

STAIN COLORS

Cappuccino	1546	Horseshoe	1760
Cherry Wood	1014	Light Pecan	1020
Cognac	1465	Natural	1007
Custom Color	CUSS	Peru	1688
Dark Cherry	1316	Pickled White	1762
Dark Walnut	1641	Saddle Brown	1694
Espresso	1716	Sienna	1685
Golden Oak	1030	Truffle	1054
Harbor Grey	1761	Unfinished	1717
Henna	1949	Walnut	1012
Homestead Oak	1943	Wheat	1710
Honey Maple	1013		

General Information

VALANCE RETURNS: HORIZONTAL BLINDS

VALANCE TYPE	BLIND TYPE	Maximum Continuous Width*		TILT TYPE	RETURN LENGTH	FULL RECESS DEPTH
		INSIDE MOUNT**	OUTSIDE MOUNT			
2½" (6.4 cm) Classic Valance  Valance Returns ½" (1.3 cm) to 1" (2.6 cm): glued 1⅛" (2.7 cm) to 4⅝" (11.8 cm): optional glued 4⅞" (12.0 cm) and greater: not glued Keystone not available	2" (5.1 cm) Traditions® Bamboo and Barnwood	94¼" (239.4 cm)	93⅝" (237.7 cm)	cord	2⅞" (7.4 cm)	3¼" (8.3 cm)
				wand	3⅞" (9.1 cm)	3⅞" (9.9 cm)
				cordless	3⅞" (8.6 cm)	3¼" (9.6 cm)
	2" (5.1 cm) Traditions Composite	106⅝" (270.9 cm)	105⅝" (267.7 cm)	cord	2⅞" (7.4 cm)	3¼" (8.3 cm)
				wand	3⅞" (9.1 cm)	3⅞" (9.9 cm)
				cordless	3⅞" (8.6 cm)	3¼" (9.6 cm)
	2½" (6.4 cm) Traditions Double Bevel Composite	106⅝" (270.9 cm)	105⅝" (267.7 cm)	cord	3⅞" (10.1 cm)	4¼" (10.8 cm)
	2" (5.1 cm) Lake Forest® Premium Faux Wood	106⅝" (270.9 cm)	105⅝" (267.7 cm)	cord	2⅞" (7.4 cm)	3¼" (8.3 cm)
	2" (5.1 cm) Lake Forest Faux Wood	106⅝" (270.9 cm)	105⅝" (267.7 cm)	wand	3⅞" (9.1 cm)	3⅞" (9.9 cm)
				cordless	3⅞" (8.6 cm)	3¼" (9.6 cm)
	2½" (6.4 cm) Lake Forest Premium Faux Wood	106⅝" (270.9 cm)	105⅝" (267.7 cm)	cord	3⅞" (10.1 cm)	4¼" (10.8 cm)
	2½" (6.4 cm) Lake Forest Faux Wood	106⅝" (270.9 cm)	105⅝" (267.7 cm)	cordless	3⅞" (9.6 cm)	4⅞" (10.5 cm)
3" (7.7 cm) Classic Valance  Valance Returns ½" (1.3 cm) to 1" (2.6 cm): glued 1⅛" (2.7 cm) to 4⅝" (11.8 cm): optional glued 4⅞" (12.0 cm) and greater: not glued	1" (2.6 cm) Traditions Wood	100¼" (254.7 cm)	98⅞" (249.9 cm)	wand	2⅞" (5.3 cm)	2⅞" (6.1 cm)
	1" (2.6 cm) Traditions Elite Wood	100¼" (254.7 cm)	98⅞" (249.9 cm)	wand	1¾" (4.5 cm)	2⅞" (5.3 cm)
	2" (5.1 cm) Grandeur™ Aluminum	100¼" (254.7 cm)	98⅞" (249.9 cm)	cord	2⅞" (7.4 cm)	3¼" (8.3 cm)
	2" (5.1 cm) Horizontal Vinyl			cordless	3⅞" (8.6 cm)	3¼" (9.6 cm)
	2" (5.1 cm) Traditions and Elite Wood			wand	3⅞" (9.1 cm)	3⅞" (9.9 cm)
	2⅝" (6.1 cm) Traditions and Elite Wood	100¼" (254.7 cm)	98⅞" (249.9 cm)	cord	3⅞" (9.6 cm)	4⅞" (10.4 cm)
				cordless	3⅞" (9.1 cm)	3⅞" (10.1 cm)
	2½" (6.4 cm) Traditions Wood Shutter Style	100¼" (254.7 cm)	97¾" (248.3 cm)	cord	3⅞" (10.1 cm)	4¼" (10.8 cm)
				cordless	3⅞" (9.6 cm)	4⅞" (10.5 cm)
	Traditions Elite Wood Vertical Blinds	100¼" (254.7 cm)	98⅞" (249.9 cm)	N/A	5½" (14.0 cm)	5⅞" (14.8 cm)
3½" (8.9 cm) Legacy Valance  Valance Returns ½" (1.3 cm) to 1" (2.6 cm): glued 1⅛" (2.7 cm) to 4⅝" (11.8 cm): optional glued 4⅞" (12.0 cm) and greater: not glued	1" (2.6 cm) Traditions Wood	100¼" (254.7 cm)	98⅞" (249.9 cm)	wand	2⅞" (5.3 cm)	2⅞" (6.2 cm)
	1" (2.6 cm) Traditions Elite Wood	100¼" (254.7 cm)	98⅞" (249.9 cm)	wand	1¾" (4.5 cm)	2⅞" (5.4 cm)
	2" (5.1 cm) Grandeur Aluminum	100¼" (254.7 cm)	98⅞" (249.9 cm)	cord	2⅞" (7.4 cm)	3⅞" (8.5 cm)
	2" (5.1 cm) Horizontal Vinyl			cordless	3⅞" (8.6 cm)	3⅞" (9.7 cm)
	2" (5.1 cm) Traditions and Elite Wood			wand	3⅞" (9.1 cm)	4" (10.2 cm)
	2⅝" (6.1 cm) Traditions and Elite Wood	100¼" (254.7 cm)	98⅞" (249.9 cm)	cord	3⅞" (9.6 cm)	4⅞" (10.4 cm)
				cordless	3⅞" (9.1 cm)	4" (10.2 cm)
	2" (5.1 cm) Traditions Elite Authentic American Hardwoods*	100¼" (254.7 cm)	98⅞" (249.9 cm)	cord	2⅞" (7.4 cm)	3⅞" (8.5 cm)
				wand	3⅞" (9.1 cm)	4" (10.2 cm)
				cordless	3⅞" (8.6 cm)	3⅞" (9.7 cm)
	2" (5.1 cm) Traditions Distressed*	100¼" (254.7 cm)	98⅞" (249.9 cm)	cord	2⅞" (7.4 cm)	3⅞" (8.5 cm)
				wand	3⅞" (9.1 cm)	4" (10.2 cm)
				cordless	3⅞" (8.6 cm)	3⅞" (9.7 cm)
	2½" (6.4 cm) Traditions Shutter Style	100¼" (254.7 cm)	98⅞" (249.9 cm)	cord	3⅞" (10.1 cm)	4⅞" (11.2 cm)
			cordless	3⅞" (9.6 cm)	4⅞" (10.7 cm)	
Traditions Elite Wood Vertical Blinds	100¼" (254.7 cm)	98⅞" (249.9 cm)	N/A	5½" (14.0 cm)	5⅞" (15.0 cm)	



*Continuous valances wider than sizes shown above will have two or more sections spliced together. Maximum width for spliced valances is 300" (762.0 cm).

Keystones not available with Elite Authentic Hardwood, Distressed, Barnwood, Bamboo, Composite or Faux Wood Valances.

**Assumes no returns on inside mount.

General Information

VALANCE RETURNS: HORIZONTAL BLINDS

VALANCE TYPE	BLIND TYPE	Maximum Continuous Width*		TILT TYPE	RETURN LENGTH	FULL RECESS DEPTH
		INSIDE MOUNT**	OUTSIDE MOUNT			
4½" (11.5 cm) Symphony Valance  Valance Returns ½" (1.3 cm) to 1" (2.6 cm): glued 1⅛" (2.7 cm) to 4⅝" (11.8 cm): optional glued 4⅞" (12.0 cm) and greater: not glued	1" (2.6 cm) Traditions® Wood	100¼" (254.7 cm)	98⅜" (249.9 cm)	wand	2⅛" (5.3 cm)	2⅜" (7.1 cm)
	1" (2.6 cm) Traditions Elite Wood	100¼" (254.7 cm)	98⅜" (249.9 cm)	wand	1¾" (4.5 cm)	2½" (6.4 cm)
	2" (5.1 cm) Grandeur™ Aluminum 2" (5.1 cm) Horizontal Vinyl 2" (5.1 cm) Traditions and Elite Wood	100¼" (254.7 cm)	98⅜" (249.9 cm)	cord	2⅞" (7.4 cm)	3⅝" (9.3 cm)
				cordless	3⅝" (8.6 cm)	4⅞" (10.5 cm)
	2⅞" (6.1 cm) Traditions and Elite Wood	100¼" (254.7 cm)	98⅜" (249.9 cm)	wand	3⅞" (9.1 cm)	4⅞" (11.0 cm)
				cordless	3⅞" (9.1 cm)	4⅞" (11.0 cm)
	2½" (6.4 cm) Traditions Shutter Style	100¼" (254.7 cm)	98⅜" (249.9 cm)	cord	3⅞" (9.1 cm)	4⅞" (11.0 cm)
cordless				3⅞" (9.6 cm)	4½" (11.5 cm)	
Traditions Elite Wood Vertical Blinds	100¼" (254.7 cm)	98⅜" (249.9 cm)	N/A	5½" (14.0 cm)	6¼" (15.9 cm)	
3" (7.7 cm) Majestic Valance  Valance Returns ½" (1.3 cm) to 1" (2.6 cm): glued 1⅛" (2.7 cm) to 4⅝" (11.8 cm): optional glued 4⅞" (12.0 cm) and greater: not glued Keystone not available	2" (5.1 cm) Traditions Composite	106⅝" (270.9 cm)	105⅝" (267.7 cm)	cord	2⅞" (7.4 cm)	3⅝" (8.6 cm)
				wand	3⅞" (9.1 cm)	4⅞" (10.4 cm)
				cordless	3⅞" (14.0 cm)	3⅞" (9.9 cm)
	2½" (6.4 cm) Traditions Double Bevel Composite	106⅝" (270.9 cm)	105⅝" (267.7 cm)	cord	3⅞" (10.1 cm)	4⅞" (11.3 cm)
	2" (5.1 cm) Lake Forest® Premium Faux Wood 2" (5.1 cm) Lake Forest Faux Wood	106⅝" (270.9 cm)	105⅝" (267.7 cm)	cord	2⅞" (7.4 cm)	3⅞" (8.6 cm)
				wand	3⅞" (9.1 cm)	4⅞" (10.4 cm)
				cordless	3⅞" (8.6 cm)	3⅞" (9.9 cm)
2½" (6.4 cm) Lake Forest Premium Faux Wood 2½" (6.4 cm) Lake Forest Faux Wood	106⅝" (270.9 cm)	105⅝" (267.7 cm)	cord	3⅞" (10.1 cm)	4⅞" (11.3 cm)	
			cordless	3⅞" (9.6 cm)	4¼" (10.8 cm)	
3⅞" (8.0 cm) Beaded Valance  Valance Returns ½" (1.3 cm) to 1" (2.6 cm): glued 1⅛" (2.7 cm) to 4⅝" (11.8 cm): optional glued 4⅞" (12.0 cm) and greater: not glued	1" (2.6 cm) Traditions Wood	100¼" (254.7 cm)	98⅜" (249.9 cm)	wand	2⅛" (5.3 cm)	2⅞" (6.1 cm)
	1" (2.6 cm) Traditions Elite Wood	100¼" (254.7 cm)	98⅜" (249.9 cm)	wand	1¾" (4.5 cm)	2⅞" (5.3 cm)
	2" (5.1 cm) Grandeur Aluminum 2" (5.1 cm) Horizontal Vinyl 2" (5.1 cm) Traditions and Elite Wood	100¼" (254.7 cm)	98⅜" (249.9 cm)	cord	2⅞" (7.4 cm)	3¼" (8.3 cm)
				wand	3⅞" (9.1 cm)	3⅞" (9.9 cm)
				cordless	3⅞" (8.6 cm)	3¼" (9.6 cm)
	2⅞" (6.1 cm) Traditions and Elite Wood	100¼" (254.7 cm)	98⅜" (249.9 cm)	cord	3⅞" (9.6 cm)	4⅞" (10.4 cm)
				cordless	3⅞" (9.1 cm)	3⅞" (10.1 cm)
2½" (6.4 cm) Traditions Shutter Style	100¼" (254.7 cm)	98⅜" (249.9 cm)	cord	3⅞" (10.1 cm)	4¼" (10.8 cm)	
			cordless	3⅞" (9.6 cm)	4⅞" (10.5 cm)	
Traditions Elite Wood Vertical Blinds	100¼" (254.7 cm)	98⅜" (249.9 cm)	N/A	5½" (14.0 cm)	5⅞" (14.8 cm)	

*Continuous valances wider than sizes shown above will have two or more sections spliced together. Maximum width for spliced valances is 300" (762.0 cm).

Keystones not available with Elite Authentic Hardwood, Distressed, Barnwood, Bamboo, Composite or Faux Wood Valances.

**Assumes no returns on inside mount.

General Information

WOOD CORNICE AND VALANCE RETURN INFORMATION					
Product and Valance Type	Standard Return Inside Width	Full Recess Depth	Product and Cornice Type	Standard Return Inside Width	Full Recess Depth
2" (5.1 cm) Horizontal Blinds					
3" (7.7 cm) Classic Wood Valance	See pages 9 and 10 for information		4½" (11.5 cm) Symphony Wood Cornice	5" (12.7 cm)	5½" (14.8 cm)
3⅝" (8.0 cm) Beaded Valance			5½" (14.0 cm) Noble Wood Cornice	5" (12.7 cm)	6" (15.3 cm)
3½" (8.9 cm) Legacy Wood Valance			7½" (19.1 cm) Noble Wood Cornice	5" (12.7 cm)	6½" (16.1 cm)
4½" (11.5 cm) Symphony Wood Valance			5½" (14.0 cm) Regal Wood Cornice	5" (12.7 cm)	6¾" (16.4 cm)
			7½" (19.1 cm) Regal Wood Cornice	5" (12.7 cm)	7" (17.8 cm)
2⅜" (6.1 cm) & 2½" (6.4 cm) Horizontal Blinds					
3" (7.7 cm) Classic Wood Valance	See pages 9 and 10 for information		4½" (11.5 cm) Symphony Wood Cornice	5" (12.7 cm)	5½" (14.8 cm)
3⅝" (8.0 cm) Beaded Valance			5½" (14.0 cm) Noble Wood Cornice	5" (12.7 cm)	6" (15.3 cm)
3½" (8.9 cm) Legacy Wood Valance			7½" (19.1 cm) Noble Wood Cornice	5" (12.7 cm)	6½" (16.1 cm)
4½" (11.5 cm) Symphony Wood Valance			5½" (14.0 cm) Regal Wood Cornice	5" (12.7 cm)	6¾" (16.4 cm)
			7½" (19.1 cm) Regal Wood Cornice	5" (12.7 cm)	7" (17.8 cm)
Cellular, Pleated and Solar/Roller Shades					
3" (7.7 cm) Classic Wood Valance	3¾" (9.6 cm)	4⅞" (10.4 cm)	4½" (11.5 cm) Symphony Wood Cornice	3¾" (9.6 cm)	4⅞" (11.6 cm)
3⅝" (8.0 cm) Beaded Valance	3¾" (9.6 cm)	4⅞" (10.4 cm)	5½" (14.0 cm) Noble Wood Cornice	3¾" (9.6 cm)	4¾" (12.1 cm)
3½" (8.9 cm) Legacy Wood Valance	3¾" (9.6 cm)	4⅞" (11.2 cm)	7½" (19.1 cm) Noble Wood Cornice	3¾" (9.6 cm)	5½" (12.9 cm)
4½" (11.5 cm) Symphony Wood Valance	3¾" (9.6 cm)	4½" (11.5 cm)	5½" (14.0 cm) Regal Wood Cornice	3¾" (9.6 cm)	5½" (13.2 cm)
			7½" (19.1 cm) Regal Wood Cornice	3¾" (9.6 cm)	5¾" (14.7 cm)
Dual Shades					
3" (7.7 cm) Classic Wood Valance*	5½" (14.0 cm)	5½" (14.8 cm)	4½" (11.5 cm) Symphony Wood Cornice	5½" (14.0 cm)	6½" (16.1 cm)
3⅝" (8.0 cm) Beaded Valance*	5½" (14.0 cm)	5½" (14.8 cm)	5½" (14.0 cm) Noble Wood Cornice	5½" (14.0 cm)	6½" (16.6 cm)
3½" (8.9 cm) Legacy Wood Valance*	5½" (14.0 cm)	6½" (15.6 cm)	7½" (19.1 cm) Noble Wood Cornice	5½" (14.0 cm)	6½" (17.4 cm)
4½" (11.5 cm) Symphony Wood Valance	5½" (14.0 cm)	6¼" (15.9 cm)	5½" (14.0 cm) Regal Wood Cornice	5½" (14.0 cm)	6½" (17.7 cm)
			7½" (19.1 cm) Regal Wood Cornice	5½" (14.0 cm)	7½" (19.1 cm)
Natural Drapes					
3" (7.7 cm) Classic Wood Valance	6" (15.3 cm)	6½" (16.1 cm)	4½" (11.5 cm) Symphony Wood Cornice	6" (15.3 cm)	6½" (17.4 cm)
3⅝" (8.0 cm) Beaded Valance	6" (15.3 cm)	6½" (16.1 cm)	5½" (14.0 cm) Noble Wood Cornice	6" (15.3 cm)	7" (17.8 cm)
3½" (8.9 cm) Legacy Wood Valance	6" (15.3 cm)	6½" (16.9 cm)	7½" (19.1 cm) Noble Wood Cornice	6" (15.3 cm)	7½" (18.6 cm)
4½" (11.5 cm) Symphony Wood Valance	6" (15.3 cm)	6¾" (17.2 cm)	5½" (14.0 cm) Regal Wood Cornice	6" (15.3 cm)	7½" (18.9 cm)
			7½" (19.1 cm) Regal Wood Cornice	6" (15.3 cm)	8" (20.4 cm)
Natural Shades					
3" (7.7 cm) Classic Wood Valance	3⅝" (9.3 cm)	3½" (10.1 cm)	4½" (11.5 cm) Symphony Wood Cornice	3⅝" (9.3 cm)	4½" (11.3 cm)
3⅝" (8.0 cm) Beaded Valance	3⅝" (9.3 cm)	3½" (10.1 cm)	5½" (14.0 cm) Noble Wood Cornice	3⅝" (9.3 cm)	4½" (11.8 cm)
3½" (8.9 cm) Legacy Wood Valance	3⅝" (9.3 cm)	4¼" (10.8 cm)	7½" (19.1 cm) Noble Wood Cornice	3⅝" (9.3 cm)	4½" (12.5 cm)
4½" (11.5 cm) Symphony Wood Valance	3⅝" (9.3 cm)	4⅞" (11.2 cm)	5½" (14.0 cm) Regal Wood Cornice	3⅝" (9.3 cm)	5½" (12.9 cm)
			7½" (19.1 cm) Regal Wood Cornice	3⅝" (9.3 cm)	5½" (14.3 cm)
Sheer Vertical Blinds					
3" (7.7 cm) Classic Wood Valance	6¼" (15.9 cm)	6½" (16.8 cm)	4½" (11.5 cm) Symphony Wood Cornice	6¼" (15.9 cm)	7½" (17.9 cm)
3⅝" (8.0 cm) Beaded Valance	6¼" (15.9 cm)	6½" (16.8 cm)	5½" (14.0 cm) Noble Wood Cornice	6¼" (15.9 cm)	7¼" (18.4 cm)
3½" (8.9 cm) Legacy Wood Valance	6¼" (15.9 cm)	6½" (17.5 cm)	7½" (19.1 cm) Noble Wood Cornice	6¼" (15.9 cm)	7½" (17.9 cm)
4½" (11.5 cm) Symphony Wood Valance	6¼" (15.9 cm)	7" (17.8 cm)	5½" (14.0 cm) Regal Wood Cornice	6¼" (15.9 cm)	7½" (19.6 cm)
			7½" (19.1 cm) Regal Wood Cornice	6¼" (15.9 cm)	8¼" (21.0 cm)
Slide-View™					
3" (7.7 cm) Classic Wood Valance	3⅝" (8.0 cm)	3⅞" (8.8 cm)	4½" (11.5 cm) Symphony Wood Cornice	3⅝" (8.0 cm)	3½" (10.1 cm)
3⅝" (8.0 cm) Beaded Valance	3⅝" (8.0 cm)	3⅞" (8.8 cm)	5½" (14.0 cm) Noble Wood Cornice	3⅝" (8.0 cm)	4½" (10.5 cm)
3½" (8.9 cm) Legacy Wood Valance	3⅝" (8.0 cm)	3¾" (9.6 cm)	7½" (19.1 cm) Noble Wood Cornice	3⅝" (8.0 cm)	4½" (11.3 cm)
4½" (11.5 cm) Symphony Wood Valance	3⅝" (8.0 cm)	3⅞" (9.9 cm)	5½" (14.0 cm) Regal Wood Cornice	3⅝" (8.0 cm)	4½" (11.6 cm)
			7½" (19.1 cm) Regal Wood Cornice	3⅝" (8.0 cm)	5½" (13.0 cm)
Sliding Panels					
3" (7.7 cm) Classic Wood Valance	5" (12.7 cm)	5½" (13.5 cm)	4½" (11.5 cm) Symphony Wood Cornice	5" (12.7 cm)	5½" (14.8 cm)
3⅝" (8.0 cm) Beaded Valance	5" (12.7 cm)	5½" (13.5 cm)	5½" (14.0 cm) Noble Wood Cornice	5" (12.7 cm)	6" (15.3 cm)
3½" (8.9 cm) Legacy Wood Valance	5" (12.7 cm)	5½" (14.3 cm)	7½" (19.1 cm) Noble Wood Cornice	5" (12.7 cm)	6½" (17.4 cm)
4½" (11.5 cm) Symphony Wood Valance	5" (12.7 cm)	5¾" (14.7 cm)	5½" (14.0 cm) Regal Wood Cornice	5" (12.7 cm)	6½" (16.4 cm)
			7½" (19.1 cm) Regal Wood Cornice	5" (12.7 cm)	7" (17.8 cm)
Vertical Blinds					
3" (7.7 cm) Classic Wood Valance	5½" (14.0 cm)	5½" (14.8 cm)	4½" (11.5 cm) Symphony Wood Cornice	5½" (14.0 cm)	6½" (16.1 cm)
3⅝" (8.0 cm) Beaded Valance	5½" (14.0 cm)	5½" (14.8 cm)	5½" (14.0 cm) Noble Wood Cornice	5½" (14.0 cm)	6½" (16.6 cm)
3½" (8.9 cm) Legacy Wood Valance	5½" (14.0 cm)	6½" (15.6 cm)	7½" (19.1 cm) Noble Wood Cornice	5½" (14.0 cm)	6½" (17.4 cm)
4½" (11.5 cm) Symphony Wood Valance	5½" (14.0 cm)	6¼" (15.9 cm)	5½" (14.0 cm) Regal Wood Cornice	5½" (14.0 cm)	6½" (17.7 cm)
			7½" (19.1 cm) Regal Wood Cornice	5½" (14.0 cm)	7½" (19.1 cm)

Note: Minimum return length is ½" (1.3 cm); maximum return length is 8" (20.4 cm).

Valance returns ½" - 1" (1.3 cm - 2.5 cm) will be glued, 1⅞" - 4⅞" (2.7 cm - 11.8 cm) optional glued, 4⅞" (12.0 cm) and greater cannot be glued.

Cornices are not available on bay or corner windows. Valances only available on bay or corner windows if bay or corner application is available on entire product line selected. See Pricing and Information Guide of product selected for measuring instructions.

If the valance or cornice is to be used alone (no product selected), the return length must be specified at the time of the order.

*Not recommended due to the height of the shade.

Dual Shades can be configured with 7½" (19.1 cm) Cornices. 5½" (14.0 cm) Cornices are available only when Dual Shade has no cassette with inside mount and Cornices are outside mount.

General Information

COMPOSITE AND FAUX WOOD VALANCE RETURNS

Product and Valance Type	Standard Return Inside Width	Full Recess Depth
Cellular, Pleated and Solar/Roller Shades		
2½" (6.4 cm) Classic Composite or Faux Wood Valance	3¾" (9.6 cm)	4⅛" (10.4 cm)
3" (7.7 cm) Majestic Composite or Faux Wood Valance	3¾" (9.6 cm)	4⅜" (11.2 cm)
Dual Shades		
2½" (6.4 cm) Classic Composite or Faux Wood Valance*	5½" (14.0 cm)	5⅜" (14.8 cm)
3" (7.7 cm) Majestic Composite or Faux Wood Valance*	5½" (14.0 cm)	6⅞" (15.6 cm)
Natural Drapes		
2½" (6.4 cm) Classic Composite or Faux Wood Valance	6" (15.3 cm)	6⅞" (16.1 cm)
3" (7.7 cm) Majestic Composite or Faux Wood Valance	6" (15.3 cm)	6⅞" (16.9 cm)
Natural Shades		
2½" (6.4 cm) Classic Composite or Faux Wood Valance	3⅞" (9.3 cm)	3⅝" (10.1 cm)
3" (7.7 cm) Majestic Composite or Faux Wood Valance	3⅞" (9.3 cm)	4¼" (10.8 cm)
Sheer Vertical Blinds		
2½" (6.4 cm) Classic Composite or Faux Wood Valance	6¼" (15.9 cm)	6⅞" (16.8 cm)
3" (7.7 cm) Majestic Composite or Faux Wood Valance	6¼" (15.9 cm)	6⅞" (17.5 cm)
Slide-View™		
2½" (6.4 cm) Classic Composite or Faux Wood Valance	3⅞" (8.0 cm)	3⅞" (8.8 cm)
3" (7.7 cm) Majestic Composite or Faux Wood Valance	3⅞" (8.0 cm)	3¾" (9.6 cm)
Sliding Panels		
2½" (6.4 cm) Classic Composite or Faux Wood Valance	5" (12.7 cm)	5⅞" (13.5 cm)
3" (7.7 cm) Majestic Composite or Faux Wood Valance	5" (12.7 cm)	5⅞" (14.3 cm)
Vertical Blinds		
2½" (6.4 cm) Classic Composite or Faux Wood Valance	5½" (14.0 cm)	5⅜" (14.8 cm)
3" (7.7 cm) Majestic Composite or Faux Wood Valance	5½" (14.0 cm)	6⅞" (15.6 cm)

NOTE: Valances only available on bay or corner windows if bay or corner application is available on entire product line selected. See Pricing and Information Guide of product selected for measuring instructions. If the valance is to be used alone (no product selected), the return length must be specified at the time of the order. *Not recommended due to the height of the shade.

HOW TO MEASURE FOR VALANCE RETURNS

Window depths vary considerably depending on the age and style of the window. **Always** measure the window depth, regardless of the type of window treatment the client is considering. Knowing the depth when the order is placed can help prevent costly errors.

Use the information in your Graber Pricing and Information Guide for Wood, Composite & Faux Wood to calculate the needed return length (chart above).

To calculate the return length, use this formula:

- (Standard Return Length) minus (Client Window Depth) = Special Return Length to order for Inside Mount Blind

Remember: The smallest return width is ½" (1.3 cm).

The length of a return and the width of a valance are measured on the inside (back side–A) of the valance, not the outside (face–B) of the valance (see diagram at right).

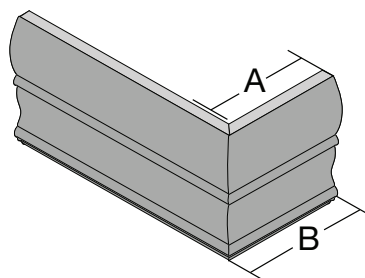

A: Inside Measurement
B: Outside Measurement

General Information

HOW TO MEASURE AND ORDER CORNICES AND VALANCES

Wood Cornices and Valances are optional with your custom order or as a stand-alone order.

NOTE: Cornices and Valances with returns are measured and cut from the **INSIDE** of the miter to ensure the most accurate fit when installed over the headrail or window frame.

Outside Mount

- Cornices and Valances are supplied with returns sized to cover the end of the blinds back to the mounting surface
- Custom returns may be ordered up to 8" (20.4 cm)
- Minimum valance return length is ½" (1.3 cm)
- Cornices include a dust cover to conceal the top of the blind

Inside Mount:

- Cornices and Valances are supplied without returns and look best when the blinds and Valance or Cornice can be completely recessed
- Ends of the Valance and Cornice are straight-cut
- Cornices do NOT have a dust cover and returns are NOT available

Additional ordering information:

- Please state at the time of order if the valance or cornice return measurements are for the **EXACT** size required so that no additions or deductions are made
- **Cornices and valances will be shipped separately from blind**
- **Manufacturer recommends installing blind and valance/cornice at the same time**

NOTE: Valances and cornices with returns are measured and cut from the **INSIDE** of the miter to ensure the most accurate fit when installed over the headrail or window frame. For different return lengths on the same valance, record **LEFT** inside measurement first. Single side returns are available; opposite end will be straight cut.

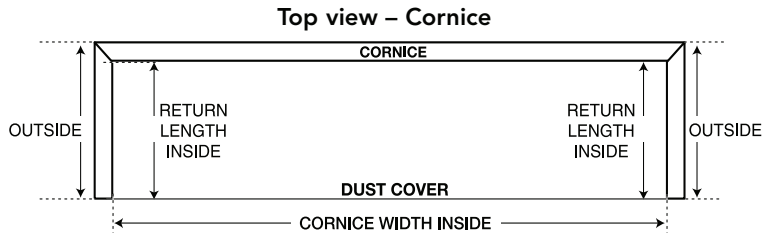

Side view — Cornice

1. Full recess is from front of cornice to wall.
2. Return length is from miter to wall.

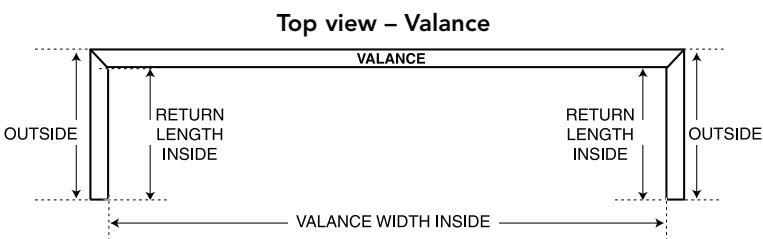
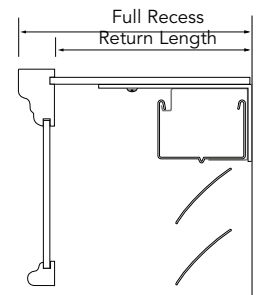

Side view — Valance

1. Full recess is from front of valance to wall.
2. Return length is from miter to wall.
3. Partial recess — subtract actual window recess from return length to arrive at exact return length.

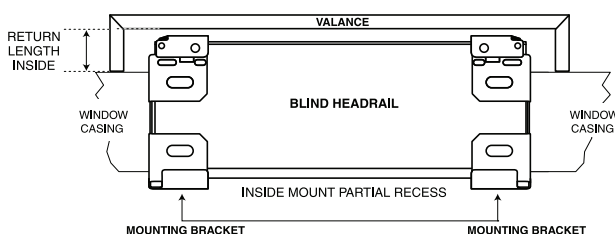
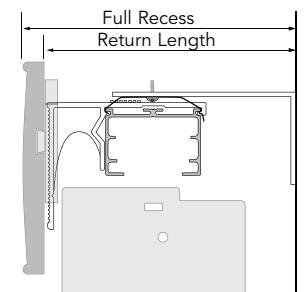

General Information

HOW TO MEASURE A SPECIAL SPLICE LOCATION

A keystone is supplied for valance widths that require a splice. Keystone will be equally spaced unless a special splice location is requested at time of order. The placement of the splice will be calculated by the factory using an **INSIDE** measurement from the mitered corner to the location specified on the order.

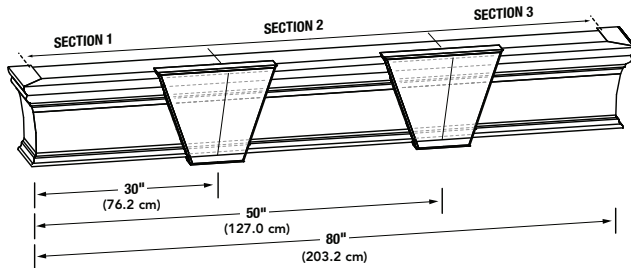

Each splice location should be recorded starting from the **LEFT BACKSIDE** corner.

Example: Overall valance width = 80" (203.2 cm) backside measurement
First splice from left = 30" (76.2 cm) backside measurement
Second splice from left = 50" (127.0 cm) backside measurement

For keystone pricing, see pricing pages.

NOTE: All measurements need to be from backside.

CUSTOM COLOR

Graber offers the unique option of custom color in either paint or stain. Use the following guidelines when placing your order.

With your order, please send a color chip (at least a 2" (5.1 cm) square sample) with the color name on the sample. A sample of the color can be requested before blinds are manufactured for your approval. An approval color sample will be automatically sent on orders for six or more blinds. A customer may waive their sample if they do not wish to receive one. Samples usually add approximately two (2) weeks to the lead time of an order. If a color sample is not requested, the sample you provided will be used to manufacture the wood blinds. If the color chip is to be returned to you, please note this on your order.

Please send all color chips to:

Springs Window Fashions
ATTN: Graber Custom Color
33 West 3rd Street, Suite 400
Williamsport, PA 17701

NOTE: Due to the nature of the custom color process, manufacturing requires an extended lead time. The standard manufacturing process does not apply. Lead-times vary depending on sizes and quantities ordered.

General Information

MOUNTING BRACKETS

Universal Cornice Mounting Bracket

- L-brackets
- Standard with any Cornice type

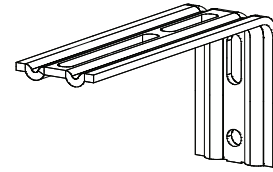

L Bracket

Universal Valance Mounting Bracket

- Standard when ordered for any of the following products:
 - Cellular, Pleated and Solar/Roller Shades
 - Dual Shades
 - Natural Shades or Drapes
 - Sheer Verticals
 - Slide-Vue™
 - Sliding Panels
 - Vertical Blinds
 - Other or Alone

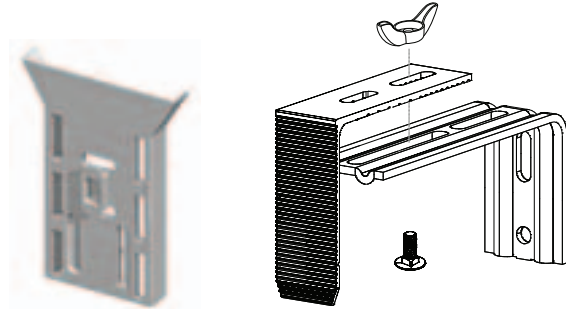

Valance Slide

Horizontal Valance Mounting Bracket

- Clip and slide brackets
- Projection length depends on slat size and control type selected
- Standard when ordered for any of the following products:
 - 2" (5.1 cm) Aluminum Horizontals
 - Composite Blinds
 - Faux Wood Blinds
 - Vinyl Horizontal Blinds
 - Wood Blinds



Valance Slide



Short Valance Clip

(Available with 2" (5.1 cm) cord or motorized tilt only)



Long Valance Clip

(Available with wand tilt or slat sizes greater than 2" (5.1 cm))